

Table of Contents

1. One-Year Limited Warranty.....	2
2. Safety Information.....	5
2.1 Conventions Used	5
2.2 Important Safety Instructions.....	5
3. Using This Manual	7
4. Introduction.....	8
4.1 About OBDII/EOBD	8
4.2 About the Code Reader	11
5. OBDII/EOBD Diagnosis	16
5.1 Reading DTCs.....	17
5.2 Clearing DTCs.....	18
5.3 Viewing Datastream.....	20
5.4 Viewing Freeze Data.....	20
5.5 Reading I/M Readiness Status Data.....	21
5.6 Reading Vehicle Information	24
5.7 Exiting Test.....	25
6. Updating the Code Reader.....	26
7. Troubleshooting	28

1. One-Year Limited Warranty

Subject to the conditions of this limited warranty, our company warrants its customer that this product is free of defects in material and workmanship at the time of its original purchase for a subsequent period of one (1) year.

In the event this product fails to operate under normal use, during the warranty period, due to defects in materials and workmanship, our company will, at its sole option, either repair or replace the product in accordance with the terms and conditions stipulated herein.

Terms and Conditions

1. If our company repairs or replaces the product, the repaired or replaced product shall be warranted for the remaining time of the original warranty period. No charge will be made to the customer for replacement parts or labor charges incurred by our company in repairing or replacing the defective parts.

2. The customer shall have no coverage or benefits under this limited warranty if any of the following conditions are applicable:

- a) The product has been subjected to abnormal use, abnormal conditions, improper storage, exposure to moisture or dampness, unauthorized modifications, unauthorized repair, misuse, neglect, abuse, accident, alteration, improper installation, or other acts which are not the fault of our company, including damage caused by shipping.
- b) The Product has been damaged from external causes such as collision with an object, or from fire, flooding, sand, dirt, windstorm, lightning, earthquake or damage from exposure to weather conditions, an Act of God, or battery leakage, theft, blown fuse, improper use of any electrical source, or the product was used in combination or connection with other product, attachments, supplies or consumables not manufactured or distributed by our company.

3. The customer shall bear the cost of shipping the product to our company. And our company shall bear the cost of shipping the product back to the customer after the completion of service under this limited warranty.

4. Our company does not warrant uninterrupted or error-free operation of the product. If a problem develops during the limited warranty period, the consumer shall take the following step-by-step procedure:

- a) The customer shall return the product to the place of purchase for repair or replacement processing; contact your local our company distributor to get further information.
- b) The customer shall include a return address, daytime phone number and/or fax number, complete description of the problem and original invoice specifying date of purchase and serial number.
- c) The customer will be billed for any parts or labor charges not covered by this limited warranty.
- d) Our company will repair the Product under the limited warranty within 30 days after receipt of the product. If our company cannot perform repairs covered under this limited warranty within 30 days, or after a reasonable number of attempts to repair the same defect, our company at its option, will provide a replacement product or refund the purchase price of the product less a reasonable amount for usage.
- e) If the product is returned during the limited warranty period, but the problem with the product is not covered under the terms and conditions of this limited warranty, the customer will be notified and given an estimate of the charges the customer must pay to have the product repaired, with all shipping charges billed to the customer. If the estimate is refused, the product will be returned freight collect. If the product is returned after the expiration of the limited warranty period, our company' normal service policies shall apply and the customer will be responsible for all shipping charges.

5. ANY IMPLIED WARRANTY OF MERCHANTABILITY, OR FITNESS FOR A PARTICULAR PURPOSE OR USE, SHALL BE LIMITED TO THE DURATION OF THE FOREGOING LIMITED WRITTEN WARRANTY. OTHERWISE, THE FOREGOING LIMITED WARRANTY IS THE CONSUMER'S SOLE AND EXCLUSIVE REMEDY AND IS IN LIEU OF ALL OTHER WARRANTIES, EXPRESS OR IMPLIED. OUR COMPANY SHALL NOT BE LIABLE FOR SPECIAL, INCIDENTAL, PUNITIVE OR CONSEQUENTIAL DAMAGES, INCLUDING BUT NOT LIMITED TO LOSS OF ANTICIPATED BENEFITS OR PROFITS, LOSS OF SAVINGS OR REVENUE, LOSS OF DATA, PUNITIVE DAMAGES, LOSS OF USE OF THE PRODUCT OR ANY ASSOCIATED EQUIPMENT, COST OF CAPITAL, COST OF ANY SUBSTITUTE EQUIPMENT OR FACILITIES, DOWNTIME, THE CLAIMS OF ANY THIRD PARTIES, INCLUDING CUSTOMERS, AND INJURY TO PROPERTY, RESULTING FROM THE PURCHASE OR USE

OF THE PRODUCT OR ARISING FROM BREACH OF THE WARRANTY, BREACH OF CONTRACT, NEGLIGENCE, STRICT TORT, OR ANY OTHER LEGAL OR EQUITABLE THEORY, EVEN IF OUR COMPANY KNEW OF THE LIKELIHOOD OF SUCH DAMAGES. OUR COMPANY SHALL NOT BE LIABLE FOR DELAY IN RENDERING SERVICE UNDER THE LIMITED WARRANTY, OR LOSS OF USE DURING THE PERIOD THAT THE PRODUCT IS BEING REPAIRED.



6. Some states do not allow limitation of how long an implied warranty lasts, so the one-year warranty limitation may not apply to you (the Consumer). Some states do not allow the exclusion or limitation of incidental and consequential damages, so certain of the above limitations or exclusions may not apply to you (the Consumer). This limited warranty gives the Consumer specific legal rights and the Consumer may also have other rights which vary from state to state.

2. Safety Information

For your safety, and to prevent damage to the equipment and vehicles, read this manual thoroughly before operating your NT200 code reader. The safety messages presented below and throughout this user's manual are reminders to the operator to exercise extreme care when using this device. Always refer to and follow safety messages and test procedures provided by the manufacturer of the vehicle or equipment being tested. Read, understand and follow all safety messages and instructions in this manual.

2.1 Conventions Used

We provide safety messages to help prevent personal injury and equipment damage. Below are signal words we used to indicate the hazard level in a condition.

No.	Signal Word	Hazard Level
1		Indicates an imminently hazardous situation which, if not avoided, will result in death or serious injury to the operator or to bystanders.
2		Indicates a potentially hazardous situation which, if not avoided, could result in death or serious injury to the operator or to bystanders.
3		Indicates a potentially hazardous situation which, if not avoided, may result in moderate or minor injury to the operator or to bystanders.

2.2 Important Safety Instructions

And always use your code reader as described in the user's manual. and follow all safety messages.

 Do not route the test cable in a manner that would interfere with driving controls.

 Do not exceed voltage limits between inputs specified in this user's manual.

 Always wear ANSI approved goggles to protect

your eyes from propelled objects as well as hot or caustic liquids.

▲WARNING Fuel, oil vapors, hot steam, hot toxic exhaust gases, acid, refrigerant and other debris produced by a malfunction engine can cause serious injury or death. Do not use code reader in areas where explosive vapor may collect, such as in below-ground pits, confined areas, or areas that are less than 18 inches (45 cm) above the floor.

▲WARNING Do not smoke, strike a match, or cause a spark near the vehicle while testing and keep all sparks, heated items and open flames away from the battery and fuel / fuel vapors as they are highly flammable.

▲WARNING Keep a dry chemical fire extinguisher suitable for gasoline, chemical and electrical fires in work area.

▲WARNING Always be aware of rotating parts that move at high speed when an engine is running and keep a safe distance from these parts as well as other potentially moving objects to avoid serious injury.

▲WARNING Do not touch engine components that get very hot when an engine is running to avoid severe burns.

▲WARNING Block drive wheels before testing with engine running. Put the transmission in park (for automatic transmission) or neutral (for manual transmission). And never leave a running engine unattended.

▲WARNING Do not wear jewelry or loose fitting clothing when working on engine.

▲WARNING Make sure to turn off ignition before connecting or disconnecting the code reader.

3. Using This Manual

We provide instructions for the usage of your code reader in this manual.

Below is a list of conventions we used in the manual.

Safety Information

See **Safety Information** on page 5-6.

Bold Text

Bold emphasis is used in procedures to highlight selectable items such as buttons and menu options.

Example:

Use the **SCROLL** key to select the desired measurement unit.

Bold-Italic Text

Bold-italic text is used in the procedures to highlight the menus on the code reader screen.

Example:

Use the **SCROLL** key to select **Language** from **System Setup** screen.

Symbols and Icons

√ Check Note

Additional information about the subject in the preceding paragraph is introduced by a √ Check Note.

Example:

√ The code reader is set to display English menus by default.

● Solid Spot

Operation tips and lists that apply to specific tool are introduced by a solid spot ●.

Example:

System Setup allows you to:

- Select menu languages.
- Change measurement unit.
- Adjust display contrast.

IMPORTANT

IMPORTANT indicates a situation which, if not avoided, may result in damage to the test equipment or vehicle.

Example:

IMPORTANT Do not soak keypad as water might find its way into the code reader.

NOTE

NOTE provides helpful information such as additional explanations, tips, and comments.

Example:

NOTE Not all data are supported by all vehicles.

Screens

Some help messages, information, and data displayed on the code reader are also shown in graphical text boxes. The screens presented are examples only and actual test screens may vary for each vehicle being tested.

Example:

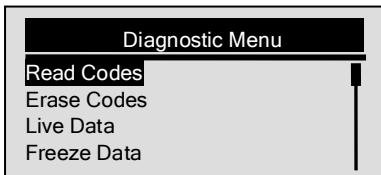

Arrow Icon

▶ An arrow icon indicates a procedure.

Example:

To change menu language:

- ▶ 1. Use the **SCROLL** key to select **Language** from **System Setup** screen.
2. Press the **YES/NO** key to confirm.

4. Introduction

NT200 is developed by the most distinguished mind of the industry. It is specially designed to read/clear codes, read live data, retrieve freeze data and request vehicle information on OBDII/EOBD compliant cars, SUVs, light-duty truck and mini-vans sold worldwide since 1996.

4.1 About OBDII/EOBD

What is OBD?

The first generation of On-Board Diagnostics or OBD I was

introduced in early 1980's to control engine functions and diagnose engine problems by vehicle manufacturers. As the OBDI lacked standardization of protocols and interface, it allowed different interpretations among vehicle manufacturers.

OBDII, the second generation On-Board Diagnostics, improved in both capability and standardization, is a system developed in mid 1990's by the Society Automotive Engineers (SAE) to standardize automotive electronic diagnosis. EOBD is European version of OBDII required in Europe since 2001.

The OBDII standard specifies:

- A generic diagnostic port (Data Link Connector) and its pinout;
- The protocols and the messaging format;
- A standard list of vehicle parameters identifications;
- A standard list of diagnostic trouble codes (DTCs);

Data Link Connector

The Data Link Connector (DLC) is a standard 16-pin interface located under the dashboard on the driver's side of the passenger compartment. If the DLC is not located under the dashboard as stated, a decal describing its location should be attached to the dashboard in the area where the DLC should have been located.

NOTE On some Asian and European vehicles the DLC is located behind the “ashtray”, which must be removed to access it, or on the far left corner of the dash. If the DLC cannot be found, consult the vehicle's service manual for the location.

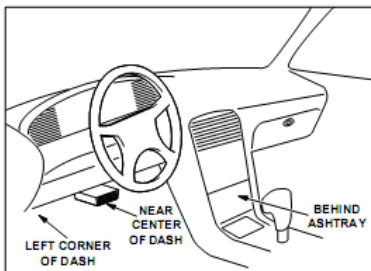

Diagnostic Trouble Codes (DTCs)

Diagnostic Trouble Codes (DTCs) are faults stored by vehicle computers when problems that affect engine performance and emissions are detected. DTCs are used to help identify the cause of a trouble or troubles with a vehicle, and determine the fault location(s).

DTCs consist of a five-digit alphanumeric code. Please see below for the DTCs format and code types.

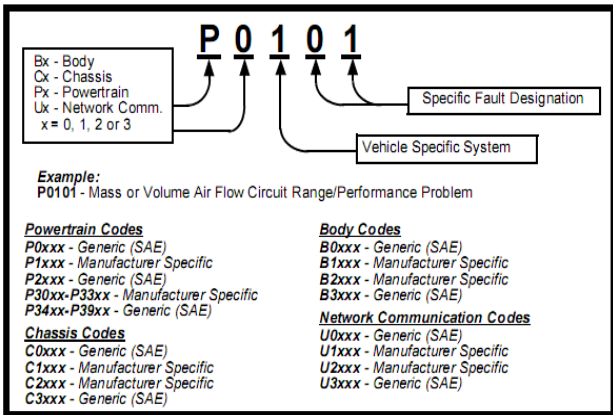

4.2 About the Code Reader

Code Reader Controls



- A. **OBD II Cable** - provides communication for vehicle DLC.
- B. **LCD Display** - shows menus, test results and operation tips.
- C. **YES/NO Key** - confirms an action or returns to previous screen or level.
- D. **SCROLL Key** - moves selection up or down. Also, press it to enter system setup menu from home screen.
- E. **USB Port** - provides a USB connection for the PC or laptop.

IMPORTANT Do not use solvents such as alcohol to clean keypad or display. Use a mild nonabrasive detergent and a soft cotton cloth.

IMPORTANT Do not soak keypad as water might find its way into the code reader.

Accessories Included

No.	Part	Description
1	User's Manual	Provides operation instructions for the usage of code reader.
2	USB Cable	Provides USB communication for updates of software and DTCs.

Specifications

No.	Item	Specification
1	Display	Backlit, 128 x 64 pixel display with contrast adjustment.
2	Working Temperature	0 to 60°C (32 to 140°F)
3	Storage Temperature	-20 to 70°C (-4 to 158°F)
4	Power	8-18 Volts powered by vehicle battery
5	Dimensions (L*W*H)	120*75*20mm (4.7*2.96*0.78in)
6	Weight	300g

Display Indicators

Below is a list indicators used to help navigate through menus.

No.	Indicator	Description
1	\$	Indicates the control unit number.
2		Indicates more than one screen of information is available.

Power

The code reader is powered up by vehicle battery.

√ Refer to **Code Reader Does Not Power Up** in section 7.2 on page 29 of **Troubleshooting** if there are problems.

To power up the code reader:

- ▶ 1. Locate the diagnostic interface on vehicle.
2. Plug in the code reader's OBDII connector to the DLC.

NOTE A plastic DLC cover may be found on some vehicles. Remove the cover before plugging the OBD2 cable.

System Setup

System Setup allows you to:

- Select menu languages.
 - Change measurement unit.
 - Adjust display contrast.
- √ **System Setup** settings remain until change to the existing setups are made.

To do system setup:

- ▶ 1. Press the **SCROLL** key to enter **System Setup** from home screen.

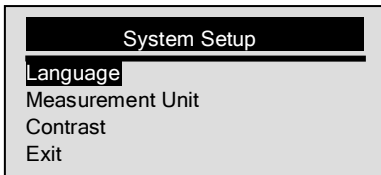

- √ Follow on-screen instructions to program the code reader to meet your specific needs.

Changing Language

- √ The code reader is set to display English menus by default.

To change menu language:

- ▶ 1. Use the **SCROLL** key to pick **Language** from **System Setup** screen.
2. Press the **YES/NO** key to confirm.

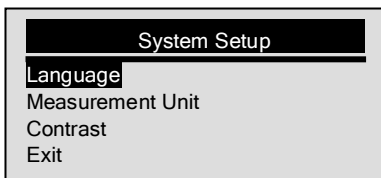

3. Use the **SCROLL** key to select desired language.



4. Press the **YES/NO** key to save language setting and return.

Changing Measurement Unit

√ Metric is the default measurement unit.

To change measurement unit:

- ▶ 1. Use the **SCROLL** key to select **Measurement Unit** from ***System Setup*** screen.
2. Press the **YES/NO** key to confirm.

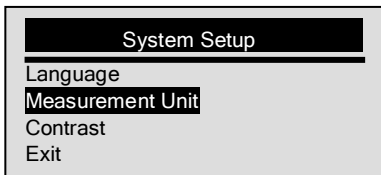

3. Use the **SCROLL** key to select desired measurement unit.

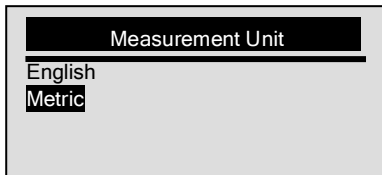

4. Press the **YES/NO** key to save measurement setting and return.

Adjusting Display Contrast

To adjust display contrast:

1. Use the **SCROLL** key to select **Contrast** from *System Setup* screen.
2. Press the **YES/NO** key to confirm.

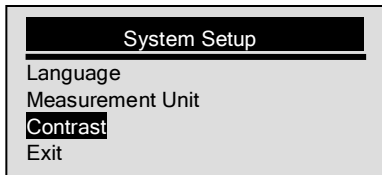

3. Use the **SCROLL** key to adjust contrast.

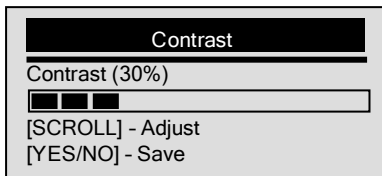

4. Press the **YES/NO** key to save contrast setting and return.

Exiting System Setup

To quit system setup:

1. Use the **SCROLL** key to move **Exit** from *System Setup* screen.
2. Press the **YES/NO** key to confirm and exit.

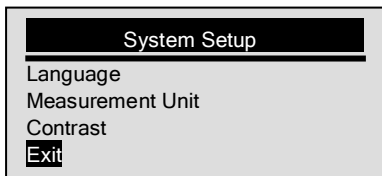

5. OBDII/EOBD Diagnosis

Diagnostic Menu allows you to:

- Read DTCs.
 - Clear DTCs.
 - View live datastream.
 - View freeze data.
 - Retrieve vehicle information.
- √ The code reader detects the communication protocol when it is connected to the vehicle and uses the protocol throughout the testing till another vehicle is diagnosed.
- √ If the code reader fails to communicate with the vehicle a "Communication Error!" message displays. Make sure the OBDII connector is securely attached, and the ignition key is on. Turn vehicle key to off for 10 seconds, then on. If problem still exists, refer to "**Error Messages**" on page 33 of **Troubleshooting**.
- √ When the code reader links to vehicle, it checks the status of I/M Monitors, and gives a summary report on the display as illustrated below.

A screenshot of a menu titled "System Status". It displays a summary report with four rows of data:

Code Found	3
Monitors N/A	4
Monitors OK	4
Monitors INC	3

- √ If vehicle is equipped with more than one computer module (for example a powertrain control module [PCM]

and a transmission control module [TCM]), the code reader identifies them by their identification names (ID) assigned by manufacturer (i.e. Engine or A/T).

- √ Use the **SCROLL** key to select a control module where the data may be retrieved when more than one module is detected.

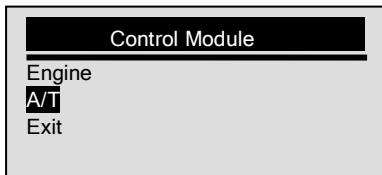

- √ To view information of other control unit quit current test and select another module.

5.1 Reading DTCs

The **Read Codes** function is used to read DTCs (stored codes), which are used to help identify the cause of a trouble or troubles with a vehicle, and pending codes from the vehicle's control modules.

- √ When emission-related or drivability fault occurs the control module illuminates the malfunction indicator lamp (MIL).
- √ Pending Codes are also referred to as continuous monitor or maturing codes that indicate intermittent faults. If the fault does not occur within a certain number of drive cycles (depending on vehicle), the code clears from memory. If fault occurs a specific number of times, the code matures into a DTC and the MIL illuminates or blinks.
- √ This function can be performed with KOEO or KOER.

To read codes from vehicle control modules:

- ▶ 1. Press the **YES/NO** key to start diagnosis from home screen.
- 2. Use the **SCROLL** key to select **Read Codes** from **Diagnostic Menu** screen.

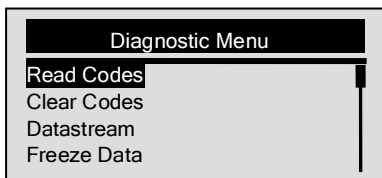

3. Press the **YES/NO** key to confirm.
4. View DTCs and their definitions.

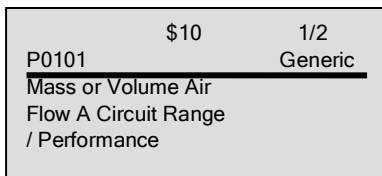

- ✓ If no DTCs are present a message stating “No (Pending) Codes Found” is displayed.
 - ✓ If any manufacturer specific or enhanced codes detected, a “Manufacturer specific codes are found! Press any key to select vehicle make!” message displays prompting you to select vehicle make before viewing DTC(s).
 - ✓ If manufacturer of the vehicle being tested is not list, select **Other**.
5. Press the **YES/NO** key to return to *Diagnostic Menu* screen.

5.2 Clearing DTCs

The **Clear Codes** function is used to delete DTCs and I/M Readiness data from vehicle’s control module(s). It may also erase freeze data, and set monitors to incomplete or not ready.

- ✓ Perform **Clear Codes** function only after systems have been checked completely.
- ✓ After servicing the vehicle, erase stored DTCs and verify no codes have been reset. If a DTC returns, problem has not been fixed or other faults are present.
- ✓ Depending on which monitor sets a code the vehicle may

need to be driven and the monitor ran before concluding that the fault is repaired.

- √ This function is performed with KOEO. Do not start the engine.

To erase codes from vehicle control modules:

- ▶ 1. Use the **SCROLL** key to select **Clear Codes** from *Diagnostic Menu* screen.

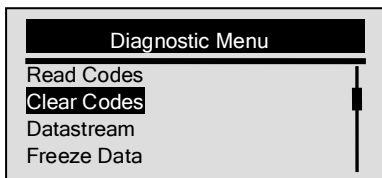

2. Press the **YES/NO** key to confirm.
3. If codes and diagnostic results are to be cleared, use the **SCROLL** key to select **YES** and press the **YES/NO** key.

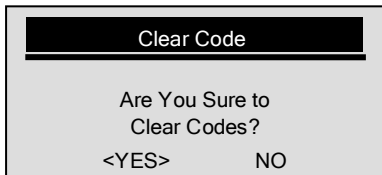

- √ If codes and test data not to be deleted, select **NO**, and a "Command Cancelled!" message displays prompting to press any key to return to *Diagnostic Menu*.
4. Wait a few seconds until a "Codes Cleared!" message shows indicating codes are cleared successfully.
- √ If the code reader fails to clear the codes, a "Clear Error! Turn Key on with Engine off!" message displays.
5. Wait a few seconds or press any key to return to *Diagnostic Menu*.

5.3 Viewing Datastream

The *Datastream* function allows real time viewing of the vehicle's electronic control unit's PID data, including sensor data, operation of switches, solenoids and relays.

To view live datastream:

1. Use the **SCROLL** key to select **Datastream** from *Diagnostic Menu* screen.

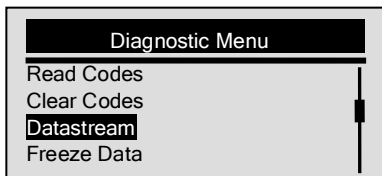

2. Press the **YES/NO** key to confirm.
3. View PIDs on code reader. Use the **SCROLL** key when more than one screen of information is retrieved.

Datastream	
DTC_CNT	2
LOAD_PCT %	0.0
ETC °F	171
RPM/min	0

√ Some vehicle may not support this function, and a "Not Support This Function!" message display.

4. Press the **YES/NO** key to return.

5.4 Viewing Freeze Data

The *Freeze Data* function is used to view freeze frame data, a snapshot of vehicle operating conditions recorded by the on-board computer at the time of an emission-related fault.

√ If codes were cleared, freeze data may not be stored in vehicle memory depending on vehicle.

To view freeze frame data:

1. Use the **SCROLL** key to select **Freeze Data** from *Diagnostic Menu* screen

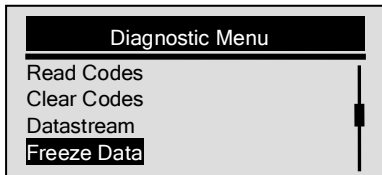

2. Press the **YES/NO** key to confirm.
3. View freeze frame data on screen. If more than one screen of information is retrieved, use the **SCROLL** key to view additional data.

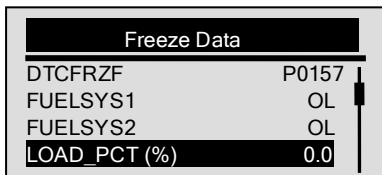

- ✓ If no freeze frame detected, a “No Freeze Data Found!” message displays.
 - ✓ Some vehicle may not support this function, and a “Not Support This Function!” message display.
4. Press the **YES/NO** key to return to *Diagnostic Menu*.

5.5 Reading I/M Readiness Status Data

The *I/M Readiness* function is used to view a snapshot of the operations for the emission system on OBDII/EOBD vehicles.

- ✓ I/M Readiness is a useful function used to check if all monitors are OK or N/A.
- ✓ The vehicle’s computer performs tests on the emission system during normal driving conditions. After a specific amount of drive time (each monitor has specific driving conditions and time required), the computer’s

monitors decide if the vehicles emission system is working correctly. When the monitor's status is:

- OK - vehicle was driven enough to complete the monitor.
- INC (Incomplete) - vehicle was not driven enough to complete the monitor.
- N/A (Not Applicable) - vehicle does not support that monitor.

√ **I/M Readiness** function is performed with the KOER or KOEO.

√ There are two types of I/M Readiness tests:

- Since DTCs Cleared - shows status of the monitors since the DTCs were last cleared.
- This Drive Cycle - shows status of monitors since the start of the current drive cycle.

√ Below is a list of abbreviations and names of OBD II monitors supported by the code reader.

No.	Abbreviation	Name
1	Misfire Monitor	Misfire Monitor
2	Fuel System Mon	Fuel System Monitor
3	Comp. Component	Comprehensive Components Monitor
4	Catalyst Mon	Catalyst Monitor
5	Htd Catalyst	Heated Catalyst Monitor
6	Evap System Mon	Evaporative System Monitor
7	Sec Air System	Secondary Air System Monitor
8	A/C Refrig Mon	Air Conditioning Refrigerant Monitor
9	Oxygen Sens Mon	Oxygen Sensor Monitor
10	Oxygen Sens Htr	Oxygen Sensor Heater Monitor
11	EGR System Mon	Exhaust Gas Recirculation System Monitor

NOTE Not all monitors are supported by all vehicles.

To retrieving I/M Readiness Status data:

- ▶ 1. Use the **SCROLL** key to select **I/M Readiness** from **Diagnostic Menu** screen.

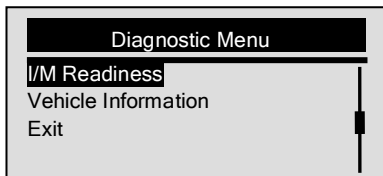

2. Press the **YES/NO** key to confirm.
√ If vehicle supports both types of monitors, please following screen:

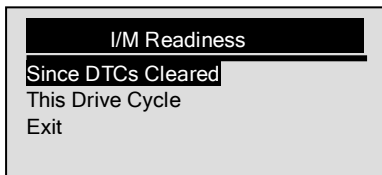

- √ Use the **SCROLL** key to select a monitor type and press the **YES/NO** key to confirm.
3. Depending on readiness test, one of these 2 screens will be present.

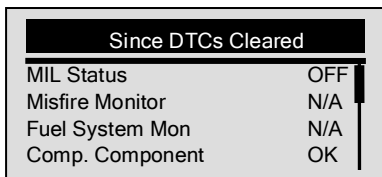

Or

This Drive Cycle	
MIL Status	OFF
Misfire Monitor	N/A
Fuel System Mon	N/A
Comp. Component	OK

- √ If more than one screen of information is retrieved, use the **SCROLL** key to view additional data.
 - √ Some vehicle may not support this function, and a “Not Support This Function!” message display.
4. Press the **YES/NO** key to return to *Diagnostic Menu*.

5.6 Reading Vehicle Information

The *Vehicle Information* function is used to request the vehicle's VIN number, calibration ID(s) which identifies software version in vehicle control module(s), calibration verification numbers (CVN(s)) and in-use performance tracking on model year 2000 and newer OBD II compliant vehicles.

- √ CVNs are calculated values required by OBD II regulations. They are reported to check if emission-related calibrations have been changed. Multiple CVNs may be reported for a control module. It may take several minutes to do the CVN calculation.
- √ In-use performance tracking tracks performance of key readiness monitors.

To request vehicle information:

- ▶ 1. Use the **SCROLL** key to select **Vehicle Information** from *Diagnostic Menu* screen.

Diagnostic Menu	
I/M Readiness	
Vehicle Information	
Exit	

2. Press the **YES/NO** key to confirm.
3. Wait a few seconds or press **YES/NO** key to continue.

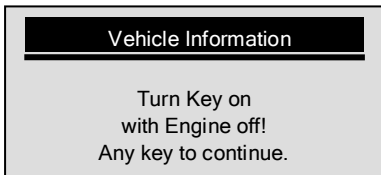

- √ Some vehicle may not support this function, and a "Not Support This Function!" message display.
4. Use the **SCROLL** key to select an available item from *Vehicle Information* screen.

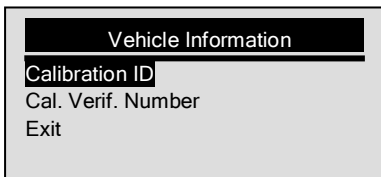

5. Press the **YES/NO** key to view retrieved information.

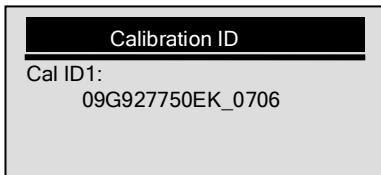

6. Press the **YES/NO** key return.

NOTE Not all data is supported by all vehicles.

5.7 Exiting Test

To exit OBDII test:

- ▶ 1. Use the **SCROLL** key to select **Exit** from *Diagnostic Menu* screen.

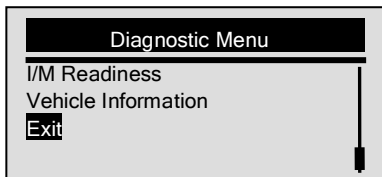

2. Press the **YES/NO** key to confirm.
3. To quit test, use the **SCROLL** key to select **YES** and press **YES/NO** key.

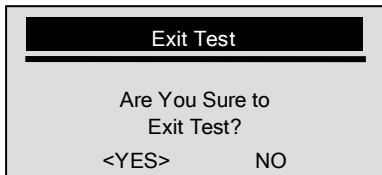

- √ If not to exit, use the **SCROLL** key the select **NO** and press the **YES/NO** key.

6. Updating the Code Reader

NT200 is able to be updated to keep you stay current with the latest development of diagnosis.

- √ The update of NT200 consists of two parts: program upgrade and DTC upgrade.
- √ To update the code reader, you need following tools:
 - NT200 Code Reader
 - Update Tool Downloaded in Our Website
 - PC or Laptop with USB Ports and Internet Explorer
 - USB Cable
- √ To be able to use update tool, PC or laptop must meet the following minimum requirements:
 - Operation System: Win98/NT, Win ME, Win2000, Win

XP, VISTA and Windows 7.

- CPU: Intel PIII or better
- RAM: 64MB or better
- Hard Disk Space: 30MB or better
- Display: 800*600 pixel, 16 byte true color display or better
- Internet Explorer 4.0 or newer

IMPORTANT Do not disconnect the code reader from computer, or power off the computer during the process of updating.

To update program:

- ▶ 1. Download the update tool and update files from our website and save the applications and files in computer disk.
2. Unzip the update tool file. Follow instructions on computer screen to install the tool and driver.
3. Double click the  desktop icon to launch the application.
4. Connect NT200 to computer with the USB cable provided and the application detect the device automatically.
5. Use <Select File> to locate update file downloaded.



6. Click <Update> to start updating.

To update DTCs:

√ It may takes several minutes to update the DTCs.

- ▶ 1. Use <Select File> to locate update file downloaded.



2. Click <Update> to start updating.

7. Troubleshooting

7.1 Error Message

When a “Communication Error!” message displays, please check the following:

- Verify ignition key is in the ON position.
- Make sure the code reader is correctly attached to vehicle’s Data Link Connector (DLC).
- Check DLC for cracked or recessed pins, or for any substance that could prevent a good electrical connection.
- Check NT200’s OBDII connector for bent or broken pins.
- Make sure the vehicle is OBDII/EOBD compliant.
- Cycle the vehicle key to OFF for 10s and then back to ON.
- Verify battery voltage is at least 8.0V with KOEO.
- Verify that the control module is not defective.

7.2 Code Reader Does Not Power Up

If NT200 will not power up, communicate with vehicle’s control module, or functions incorrectly in any other way, do the following:

- Check DLC for broken or bent pins and clean the pins if need be.
- Make sure NT200 is correctly connected to vehicle’s DLC.
- Verify battery voltage is at least 8.0V with KOEO.